

Isometric View

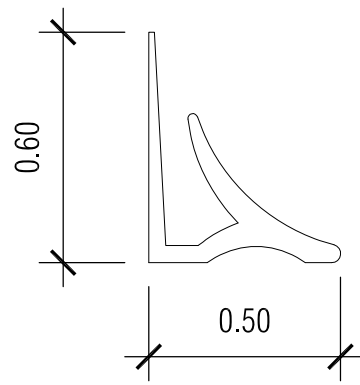

1 SIDE VIEW
scale: 2:1

NOTES:

- 1.
- 2.
- 3.

TOLERANCES UNLESS OTHERWISE NOTED:

METRIC mm TWO PLACE X.XX ± 0.13 ONE PLACE X.X ± 0.3
 INCH DECIMALS ± 0.005 FRACTIONS ± 0.010 ANGLES ± 1°

REVISION HISTORY

REV	ECO No.	DESCRIPTION	DRAWN BY
-	-	-	-
-	-	-	-
-	-	-	-
-	-	-	-



1500 Taylor Avenue
 Springfield, Illinois 62703
 (800) 826-4132

TITLE

VINYL EXTRUSION
V-5

PROPRIETARY - THIS DRAWING CONTAINS INFORMATION PROPRIETARY AND CONFIDENTIAL TO NUDO PRODUCTS.
 ANY REPRODUCTION, DISCLOSURE, DISTRIBUTION OR USE WITHOUT EXPRESS WRITTEN CONSENT OF NUDO PRODUCTS IS PROHIBITED.